

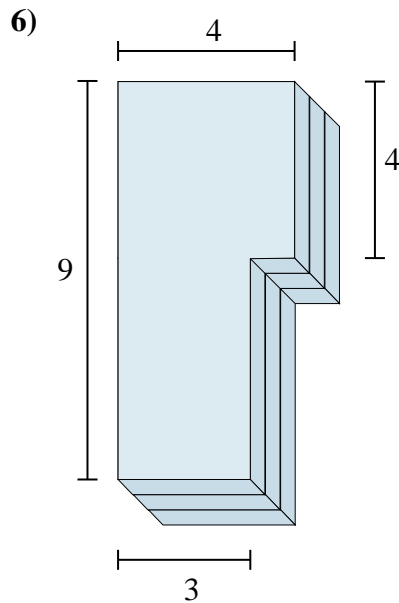

Encontrar el valor total de cada figura mostrada.

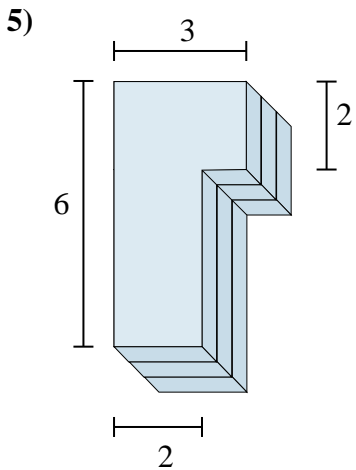
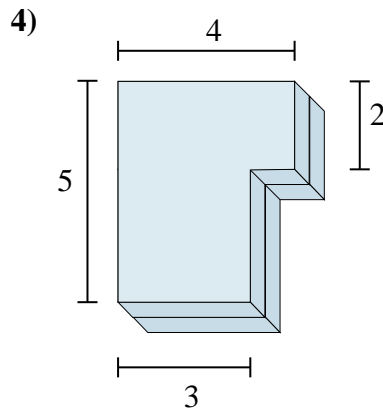
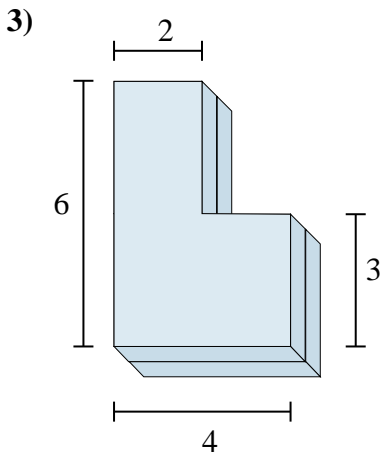
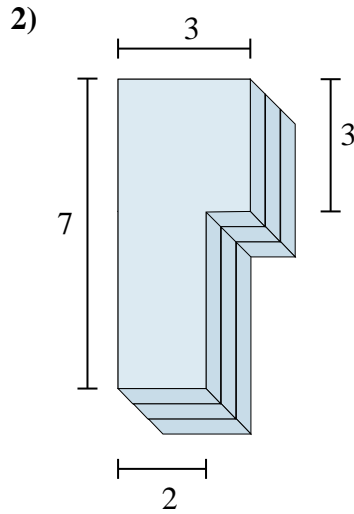
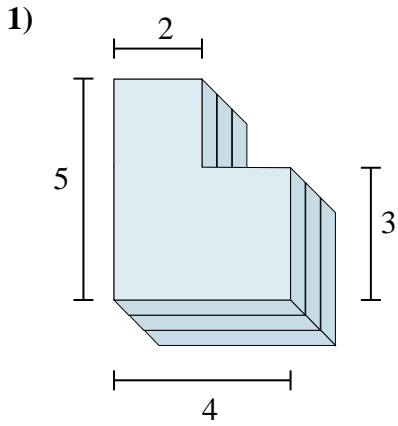

Respuestas

1. _____

2. _____

3. _____

4. _____

5. _____

6. _____



Encontrar el valor total de cada figura mostrada.

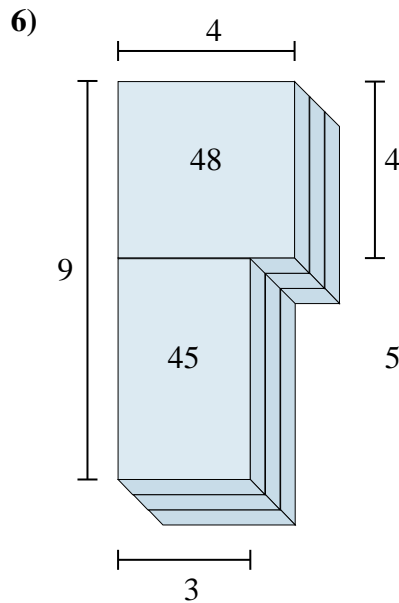
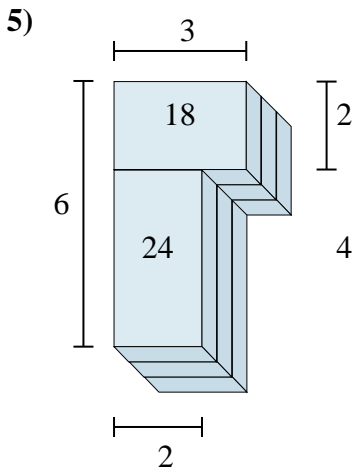
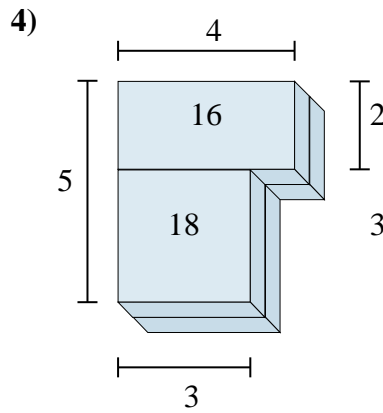
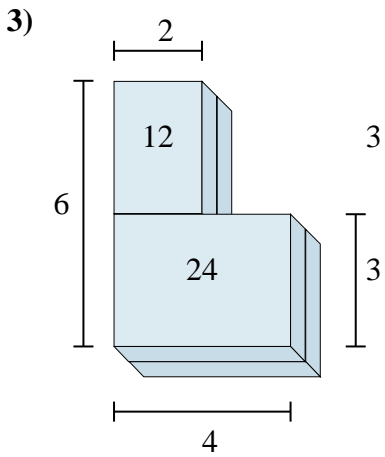
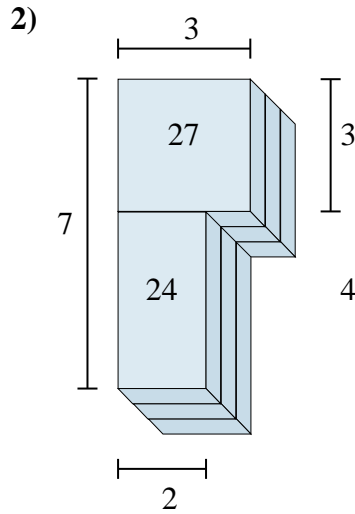
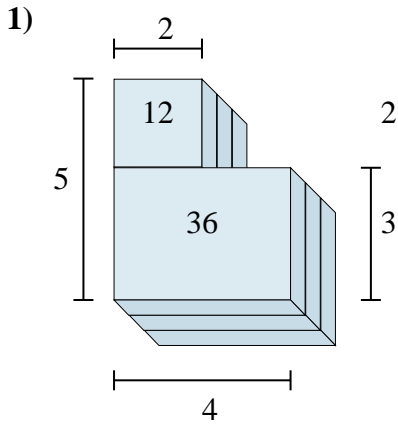

Respuestas

1. 48cm³
2. 51cm³
3. 36cm³
4. 34cm³
5. 42cm³
6. 93cm³



Encontrar el valor total de cada figura mostrada.

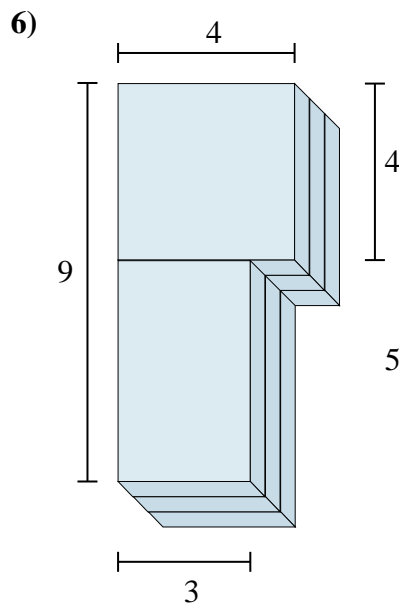
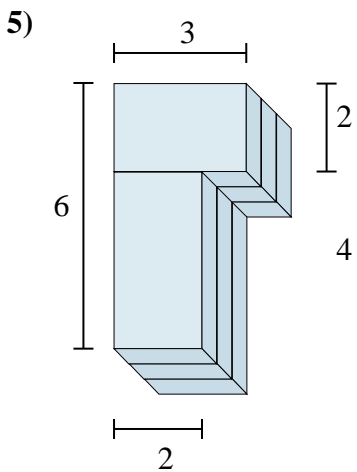
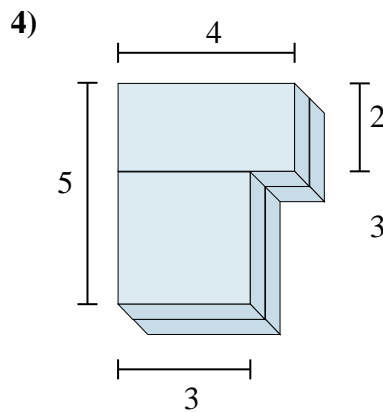
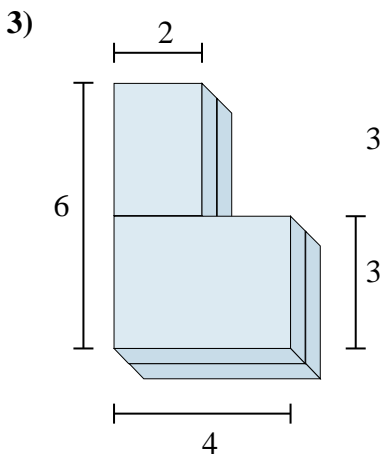
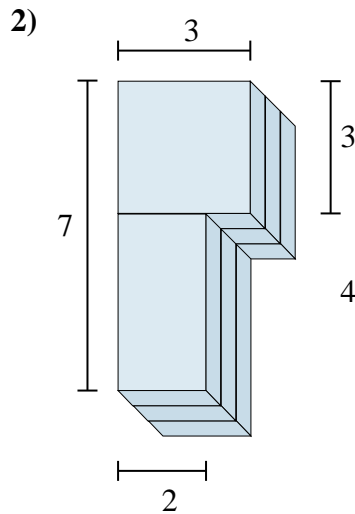
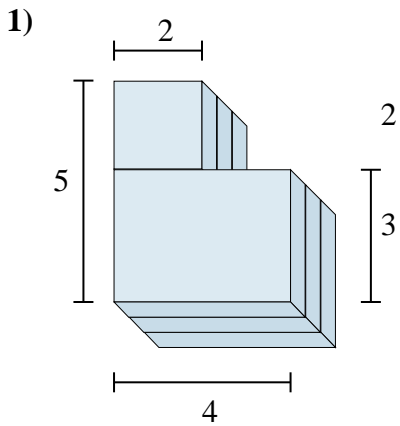

Respuestas

1. _____
2. _____
3. _____
4. _____
5. _____
6. _____