

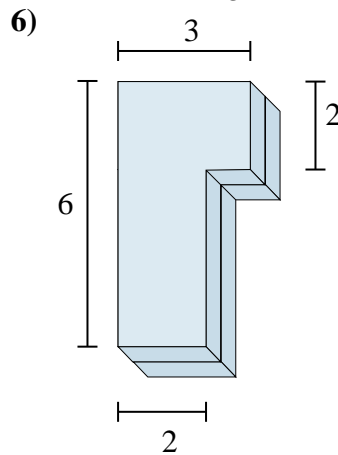

Encontrar el valor total de cada figura mostrada.

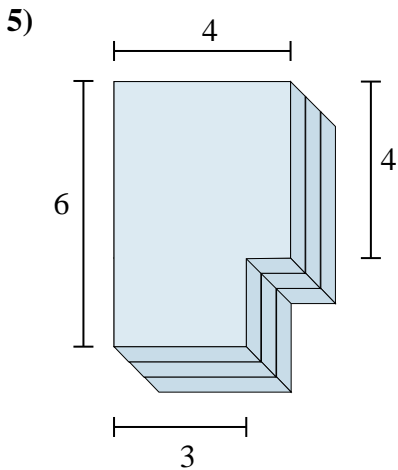
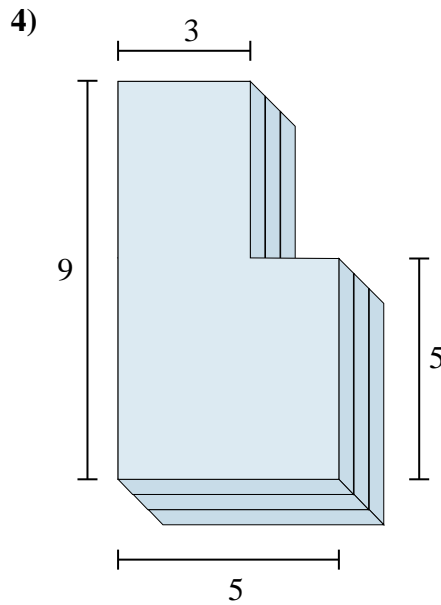
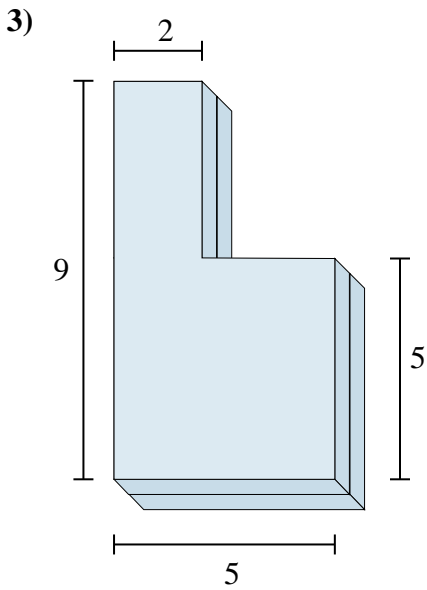
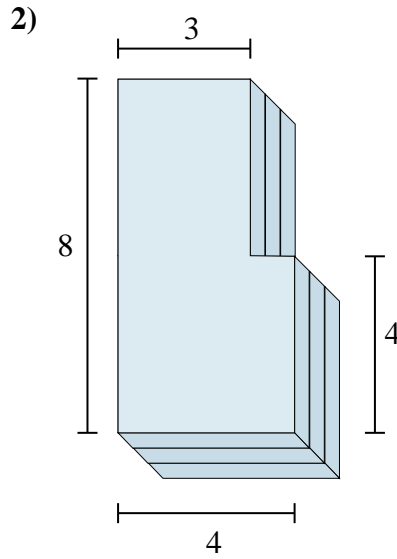
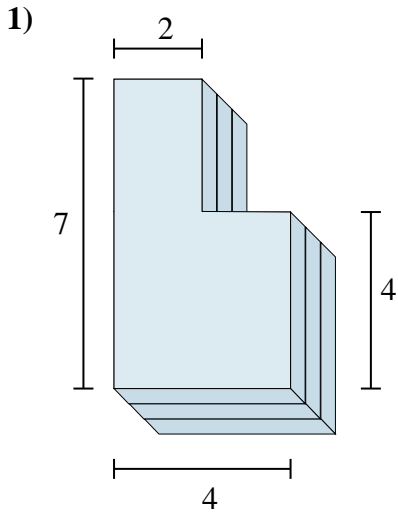

**Respuestas**

1. \_\_\_\_\_

2. \_\_\_\_\_

3. \_\_\_\_\_

4. \_\_\_\_\_

5. \_\_\_\_\_

6. \_\_\_\_\_



Encontrar el valor total de cada figura mostrada.

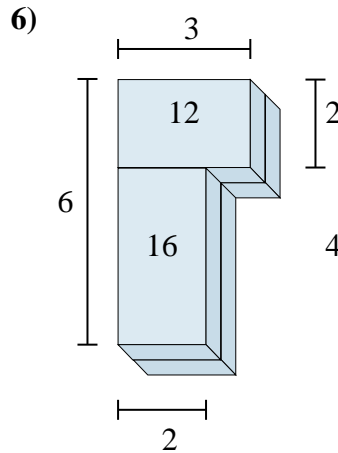
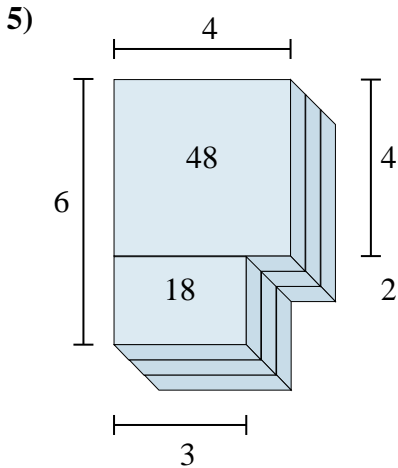
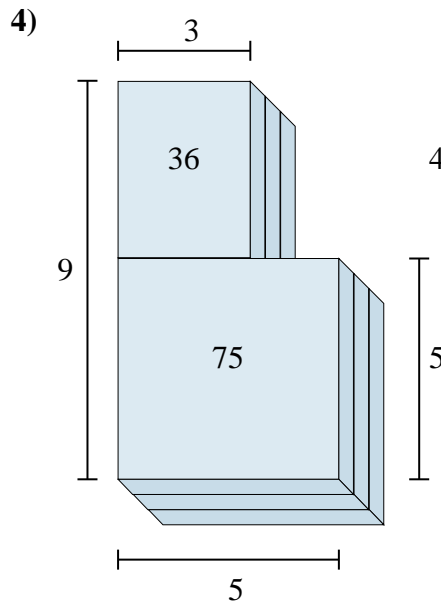
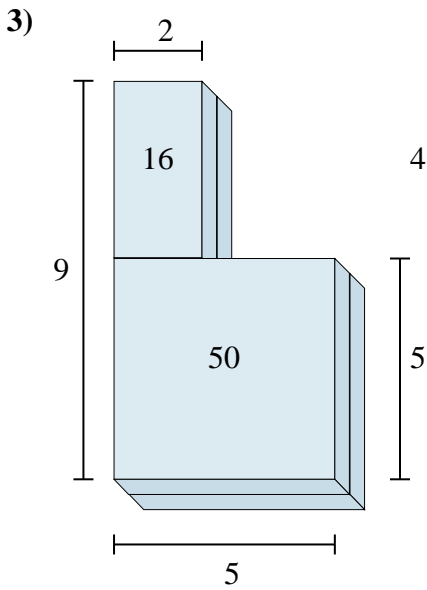
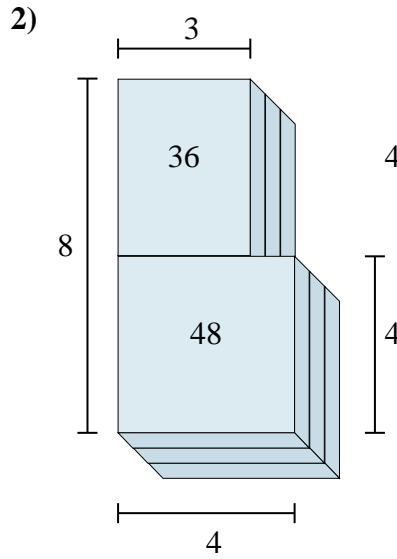
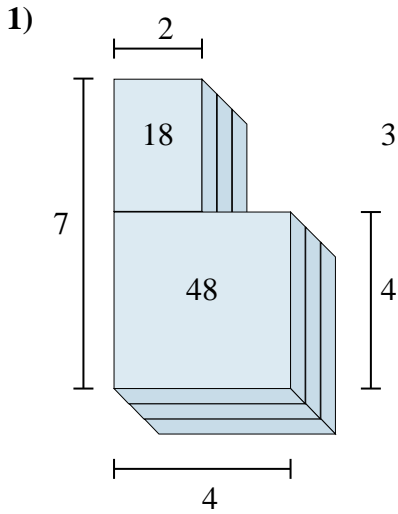

Respuestas

1. 66cm<sup>3</sup>
2. 84cm<sup>3</sup>
3. 66cm<sup>3</sup>
4. 111cm<sup>3</sup>
5. 66cm<sup>3</sup>
6. 28cm<sup>3</sup>



Encontrar el valor total de cada figura mostrada.

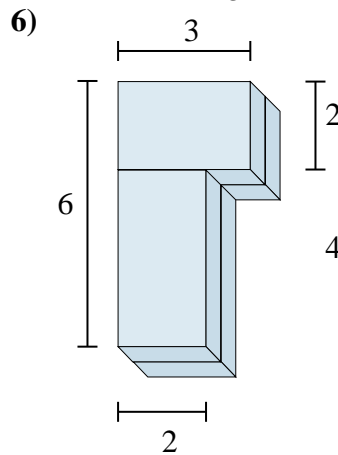
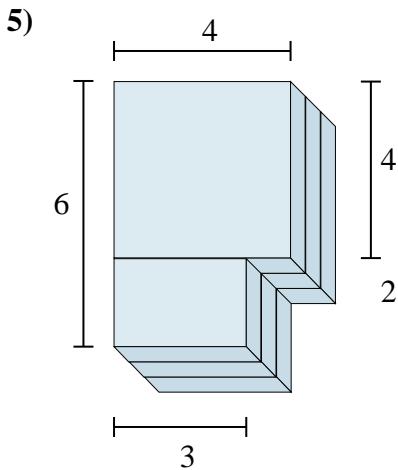
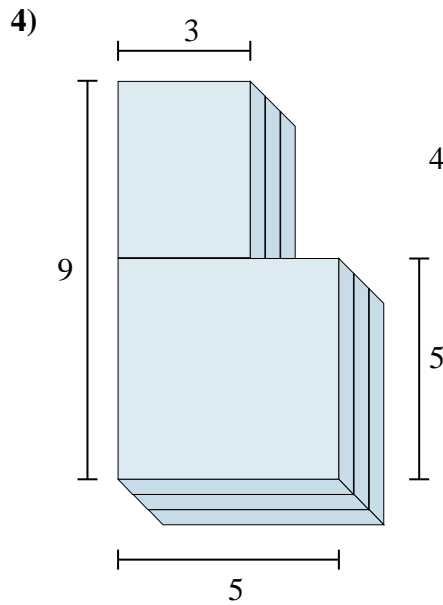
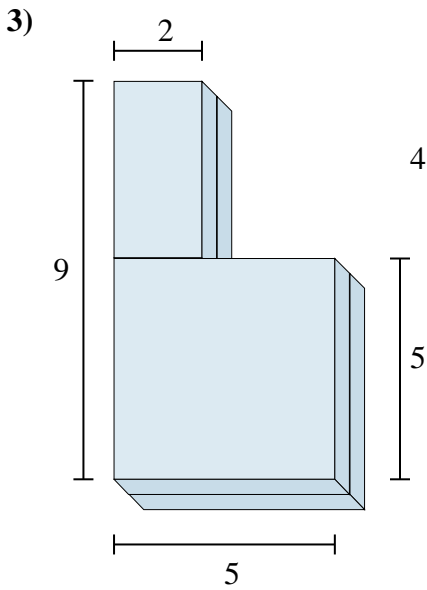
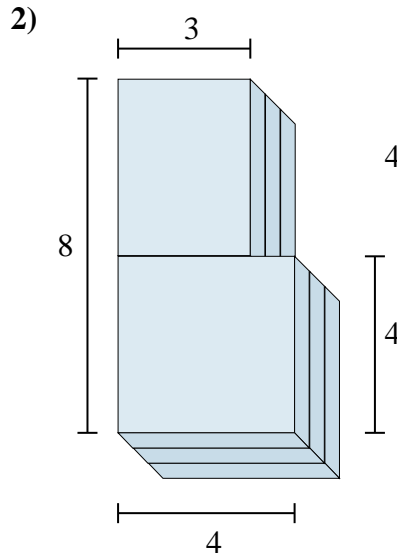
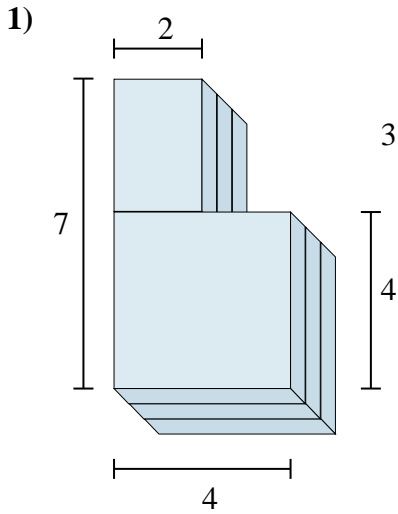

**Respuestas**

1. \_\_\_\_\_
2. \_\_\_\_\_
3. \_\_\_\_\_
4. \_\_\_\_\_
5. \_\_\_\_\_
6. \_\_\_\_\_