

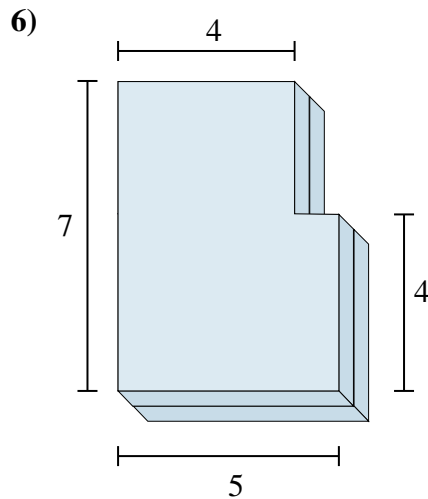

Encontrar el valor total de cada figura mostrada.

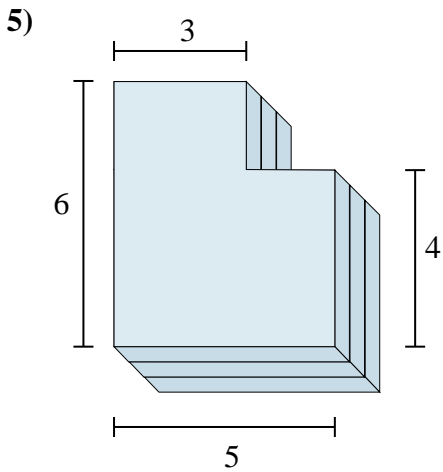
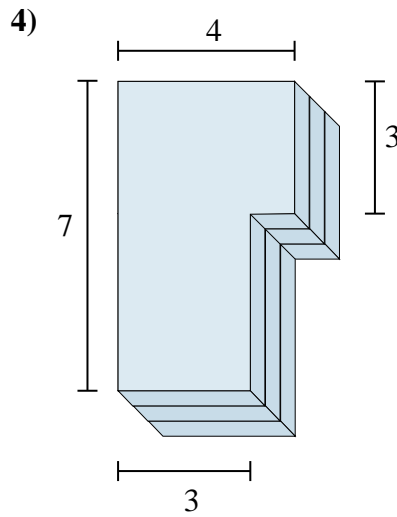
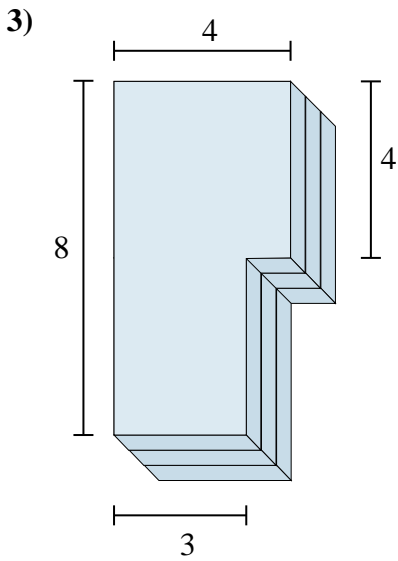
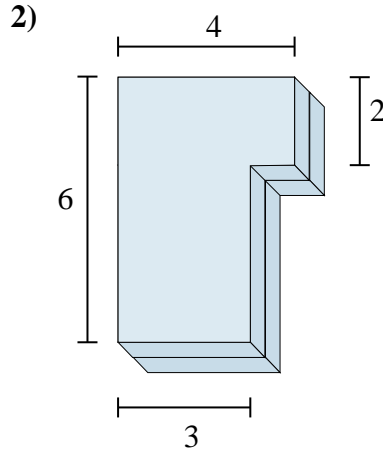
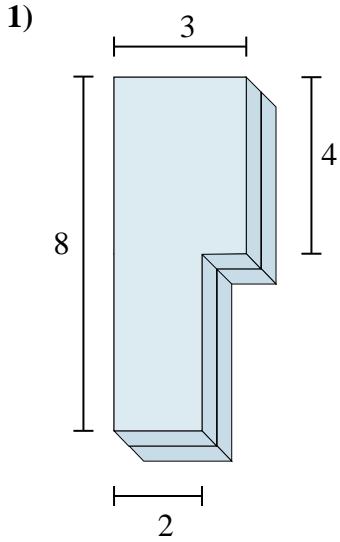

Respuestas

1. _____

2. _____

3. _____

4. _____

5. _____

6. _____



Encontrar el valor total de cada figura mostrada.

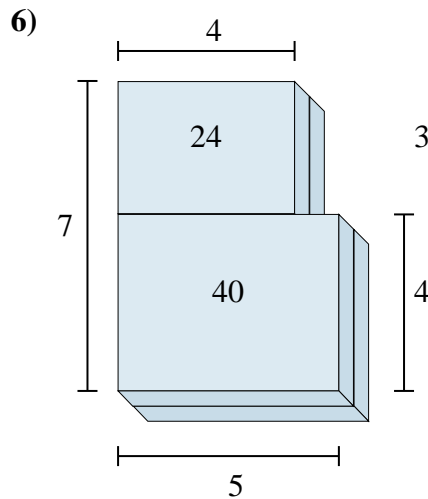
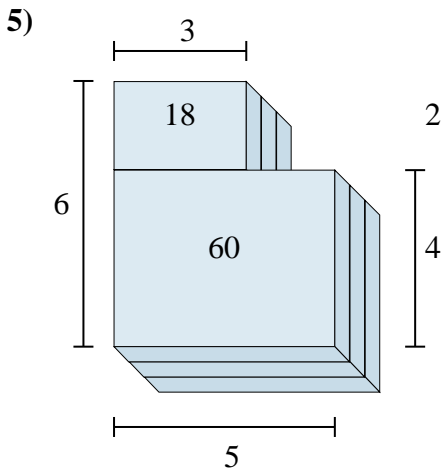
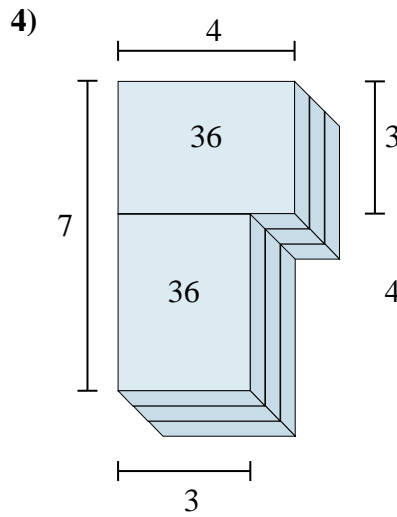
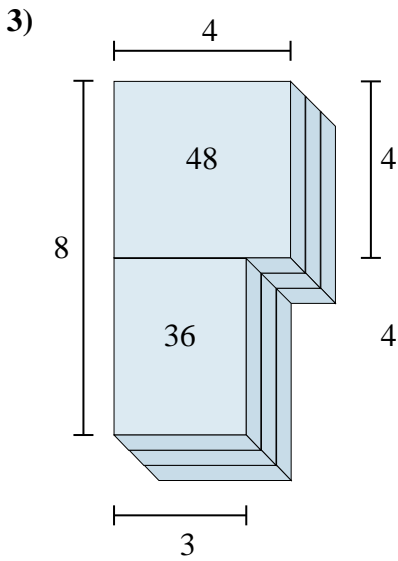
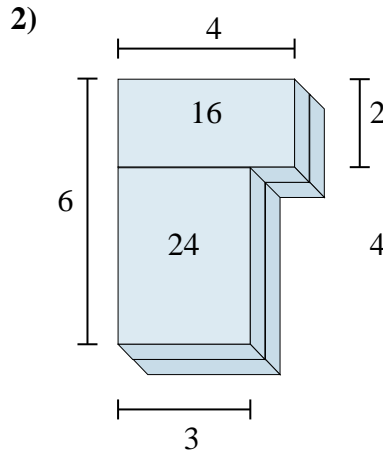
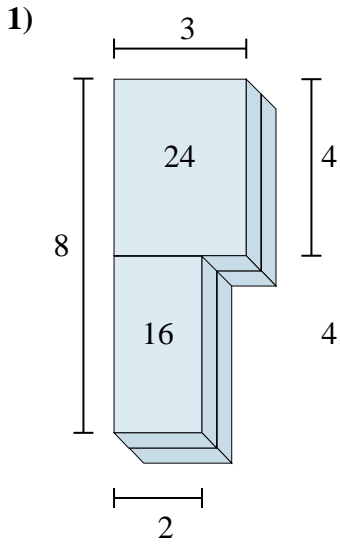

Respuestas

1. 40cm³

2. 40cm³

3. 84cm³

4. 72cm³

5. 78cm³

6. 64cm³



Encontrar el valor total de cada figura mostrada.

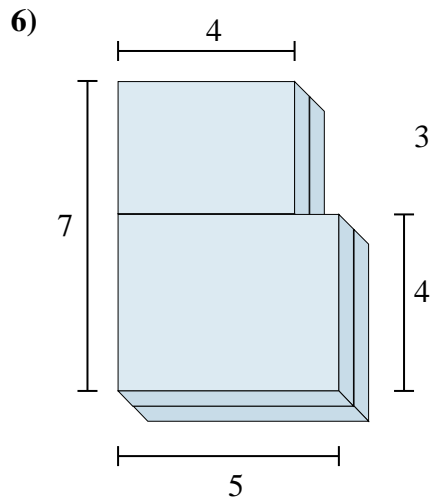
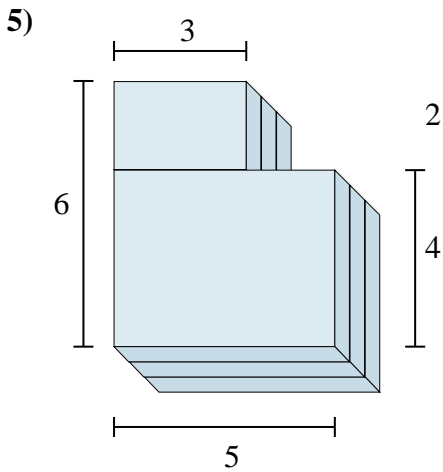
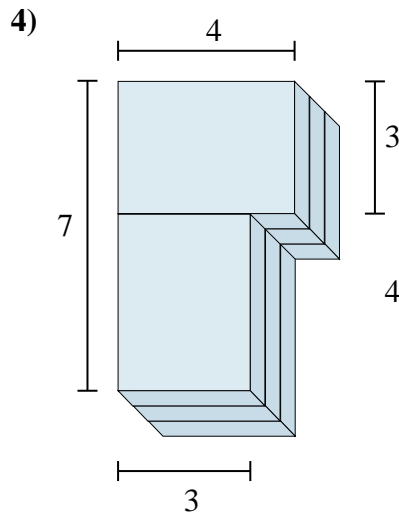
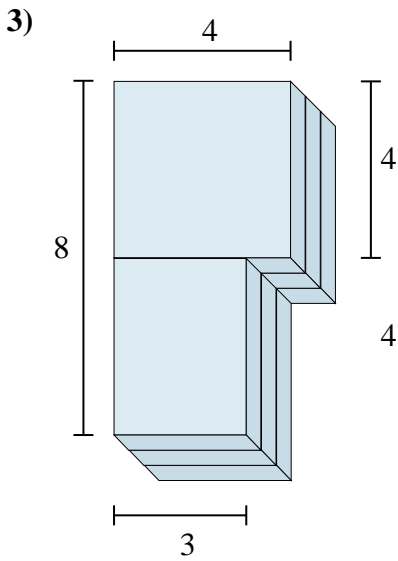
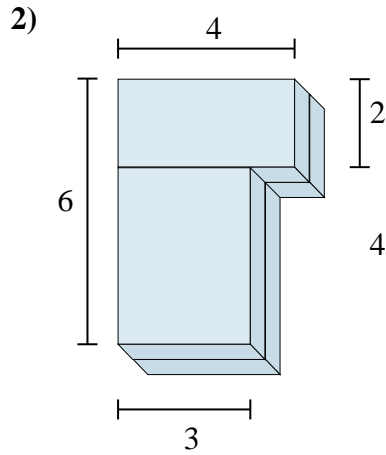
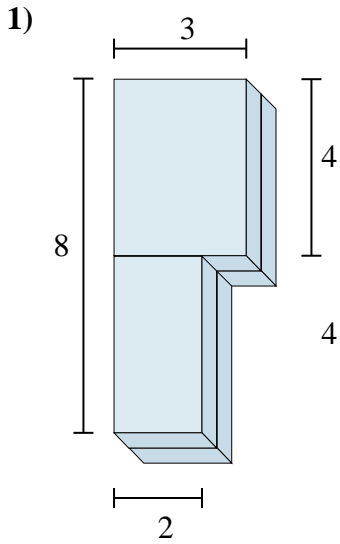

Respuestas

1. _____

2. _____

3. _____

4. _____

5. _____

6. _____