

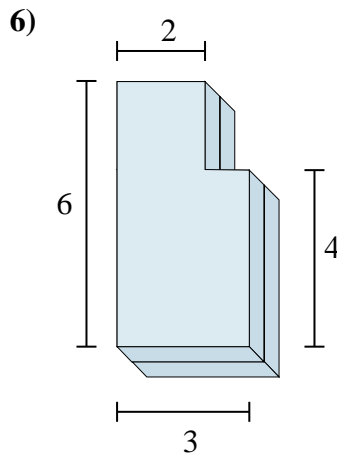

Encontrar el valor total de cada figura mostrada.

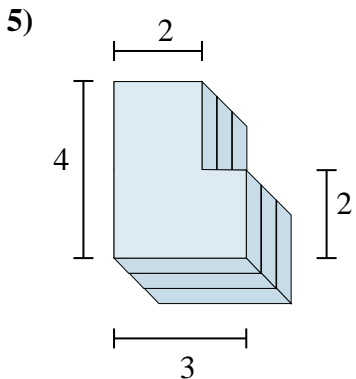
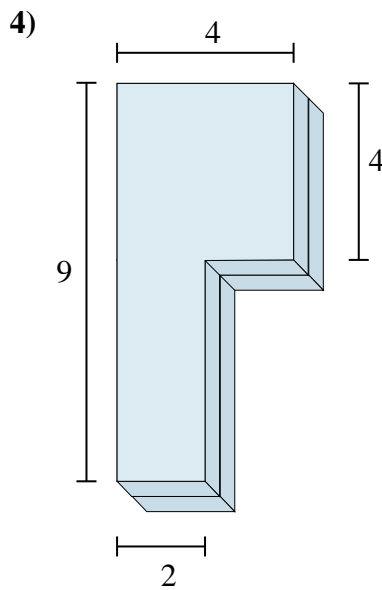
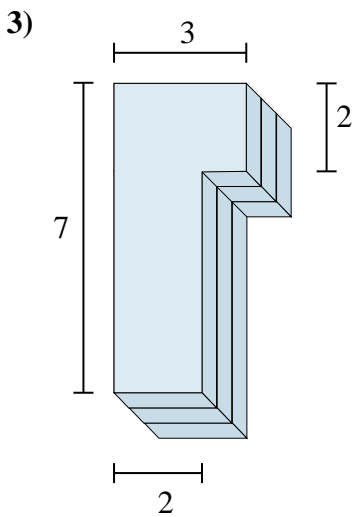
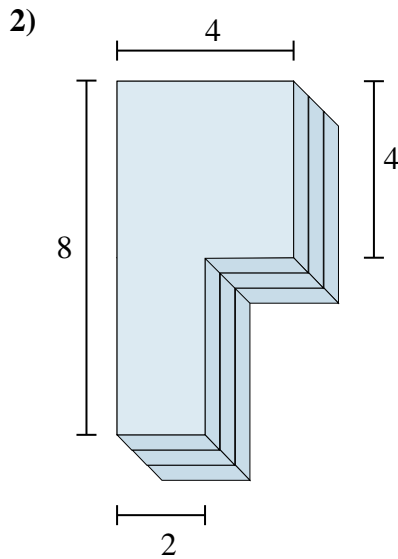
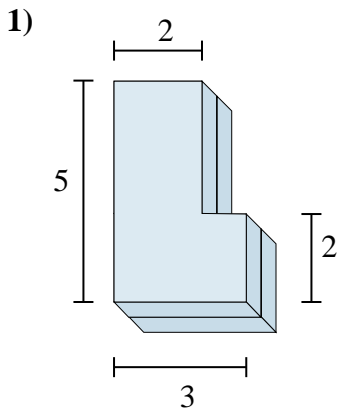

**Respuestas**

1. \_\_\_\_\_
2. \_\_\_\_\_
3. \_\_\_\_\_
4. \_\_\_\_\_
5. \_\_\_\_\_
6. \_\_\_\_\_



Encontrar el valor total de cada figura mostrada.

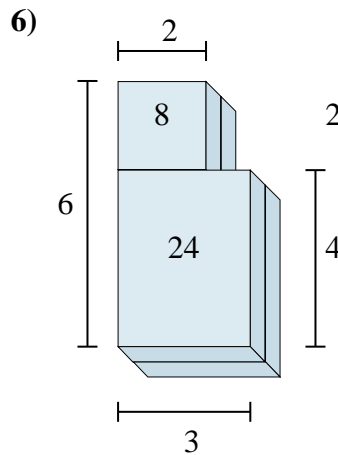
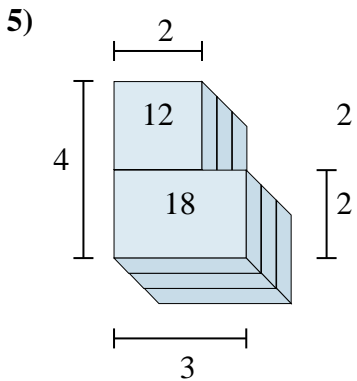
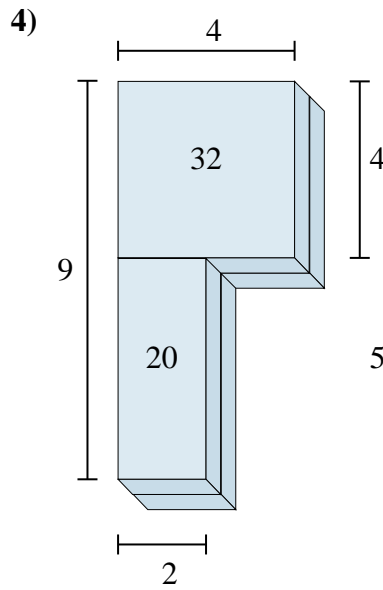
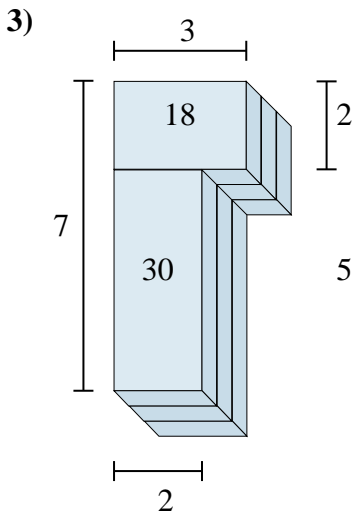
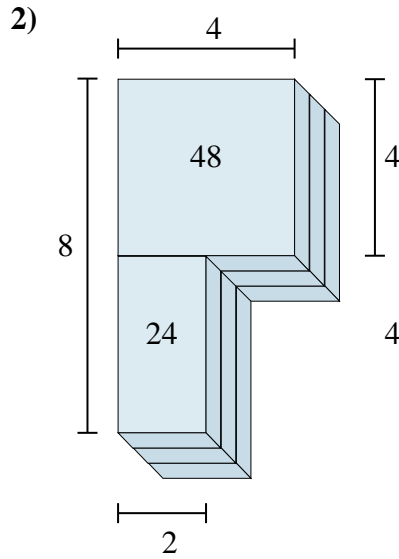
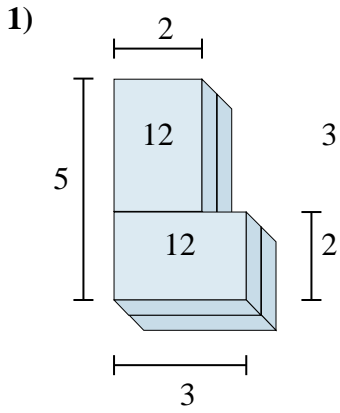

Respuestas

1. 24cm<sup>3</sup>
2. 72cm<sup>3</sup>
3. 48cm<sup>3</sup>
4. 52cm<sup>3</sup>
5. 30cm<sup>3</sup>
6. 32cm<sup>3</sup>



Encontrar el valor total de cada figura mostrada.

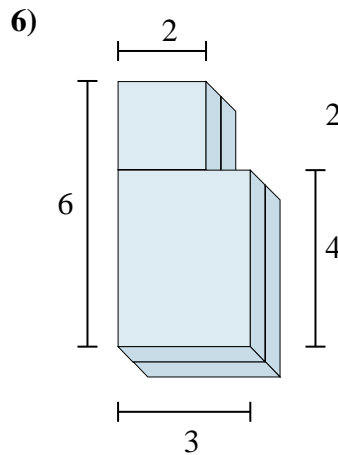
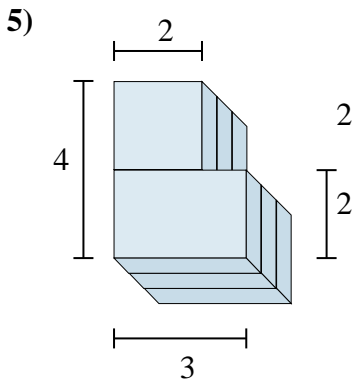
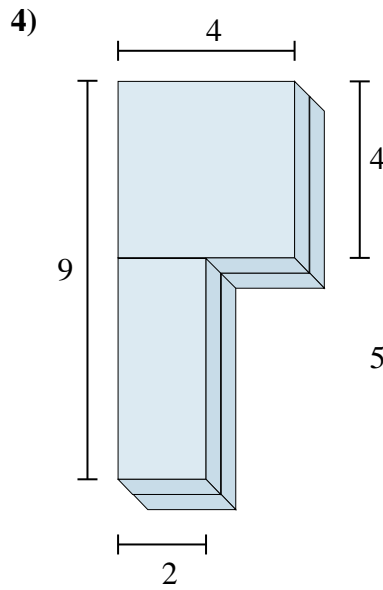
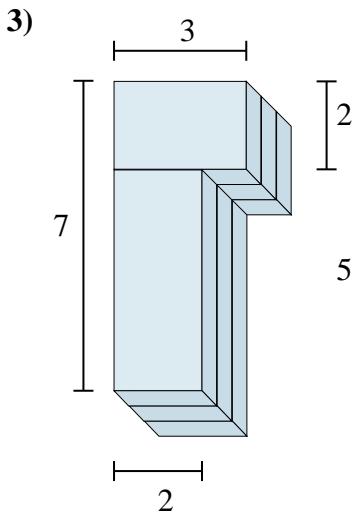
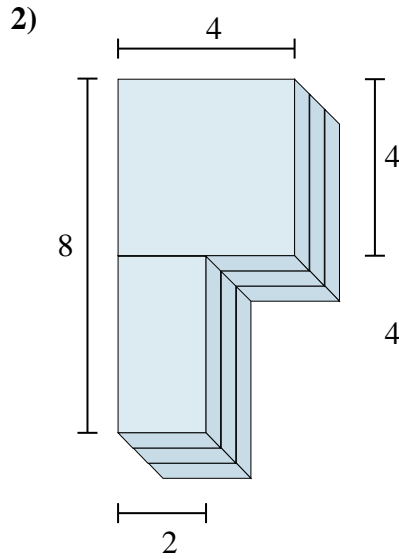
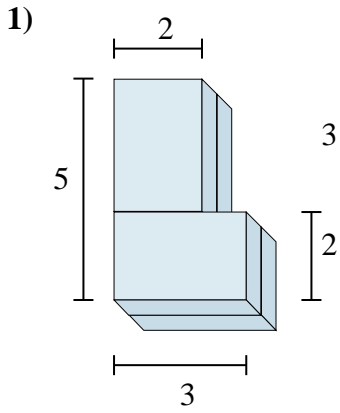

**Respuestas**

1. \_\_\_\_\_

2. \_\_\_\_\_

3. \_\_\_\_\_

4. \_\_\_\_\_

5. \_\_\_\_\_

6. \_\_\_\_\_