

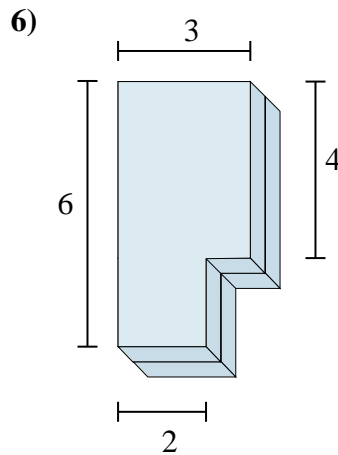

Encontrar el valor total de cada figura mostrada.

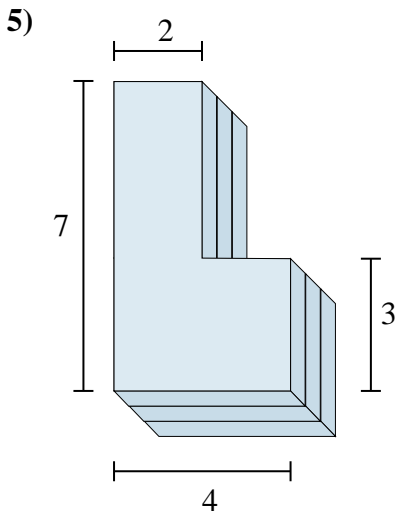
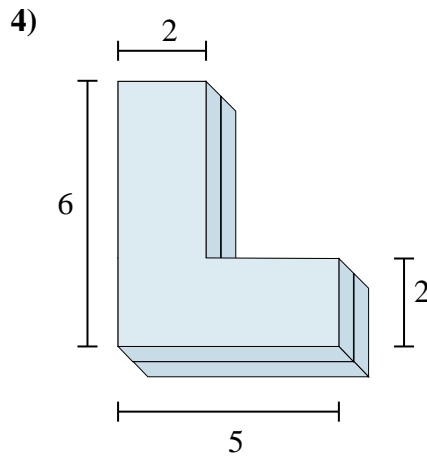
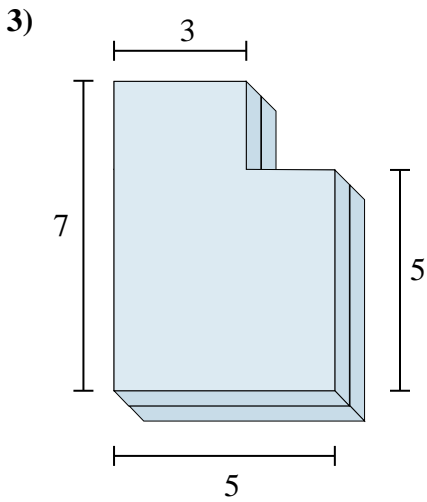
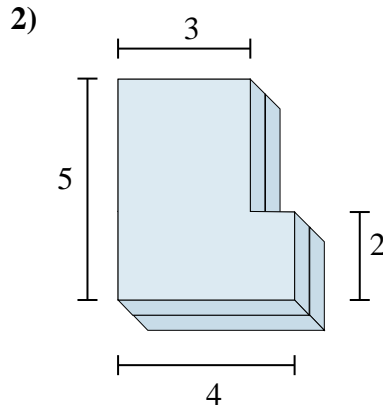
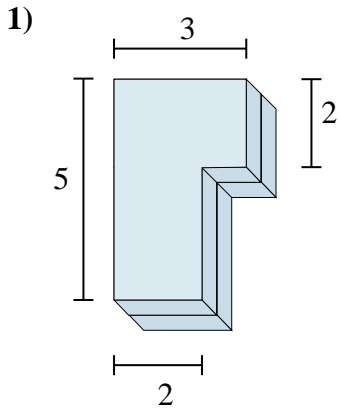

Respuestas

1. _____

2. _____

3. _____

4. _____

5. _____

6. _____



Encontrar el valor total de cada figura mostrada.

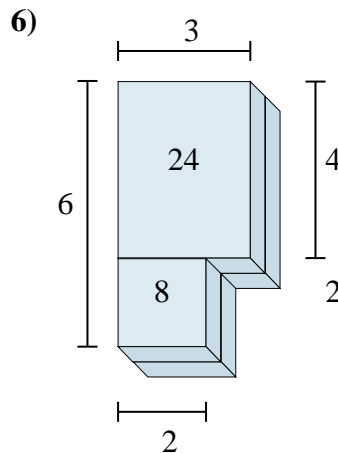
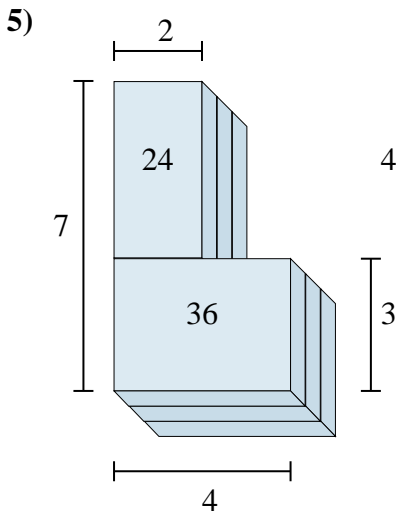
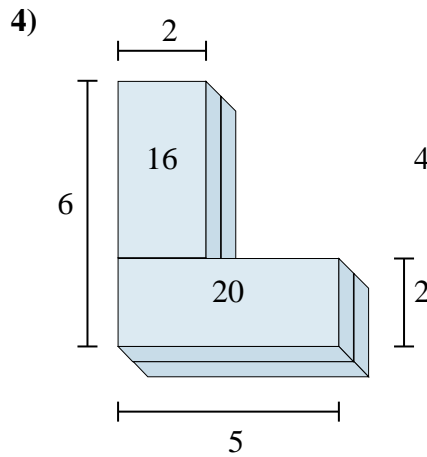
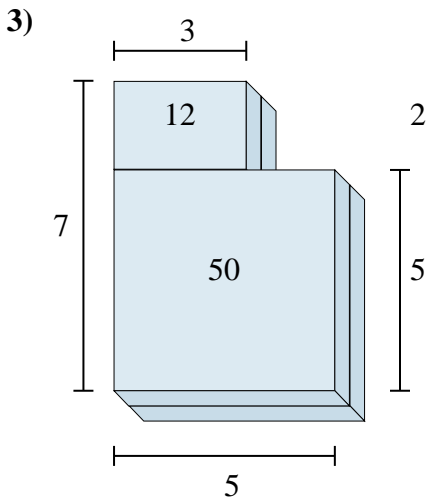
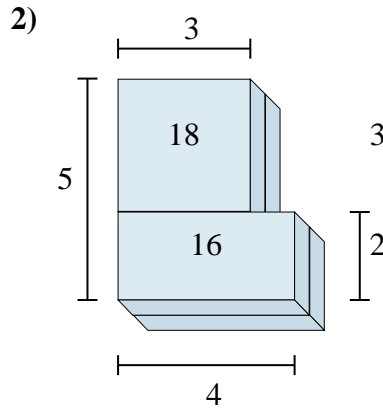
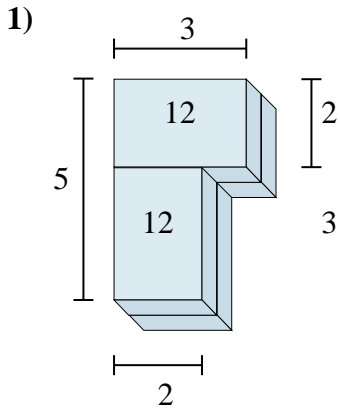

Respuestas

1. 24cm³

2. 34cm³

3. 62cm³

4. 36cm³

5. 60cm³

6. 32cm³



Encontrar el valor total de cada figura mostrada.

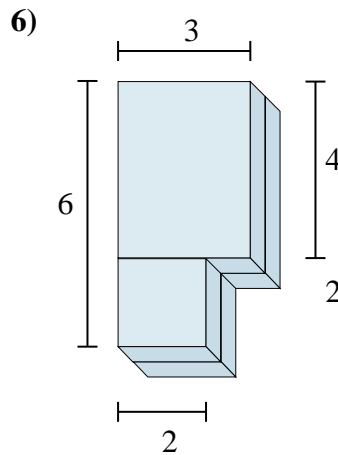
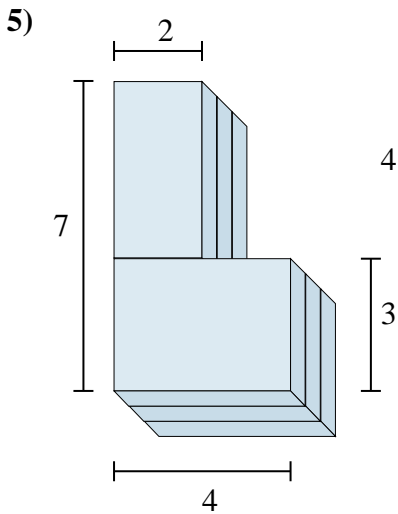
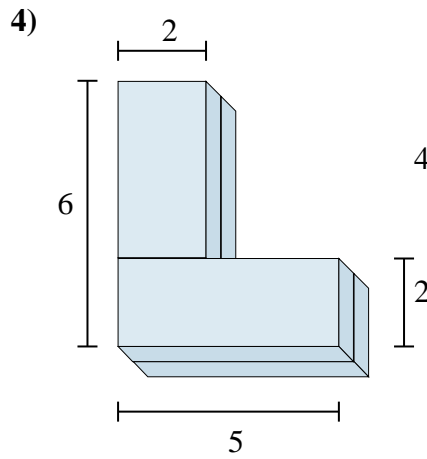
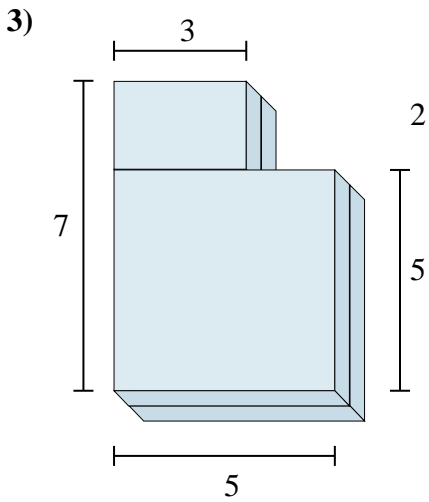
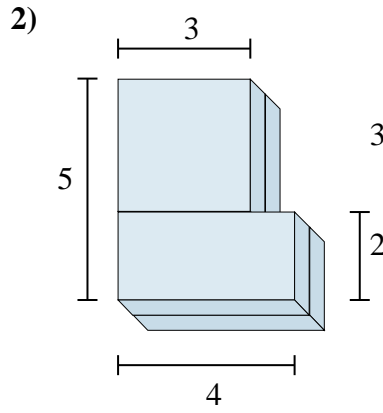
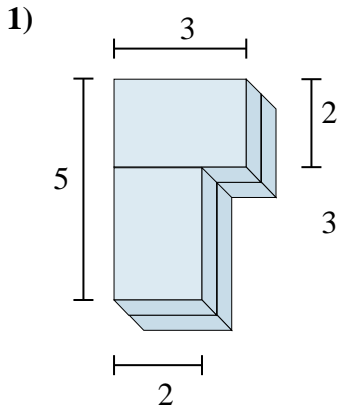

Respuestas

1. _____

2. _____

3. _____

4. _____

5. _____

6. _____