

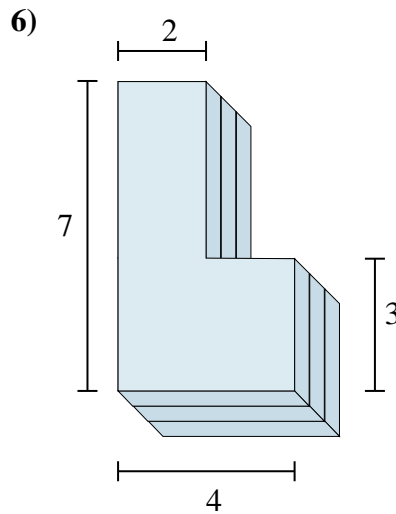

Encontrar el valor total de cada figura mostrada.

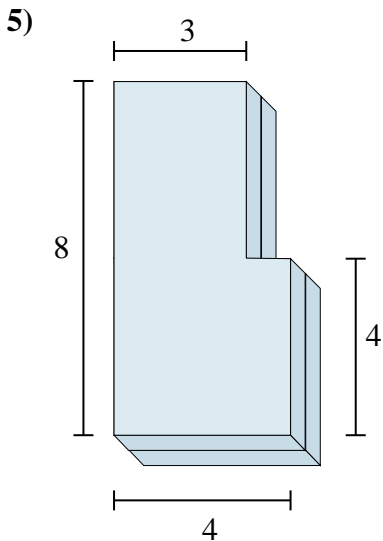
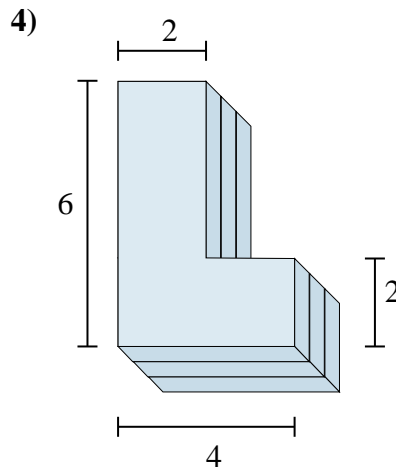
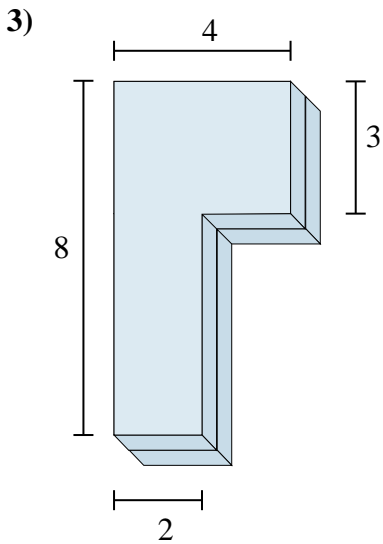
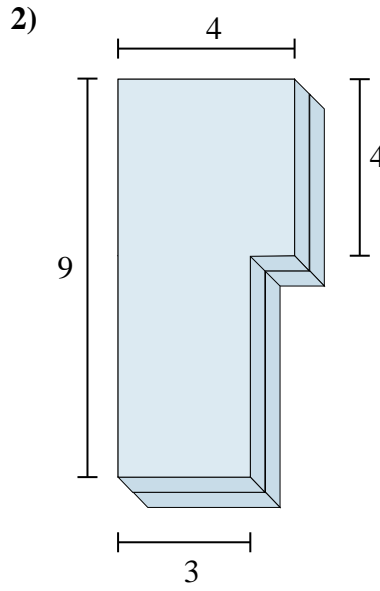
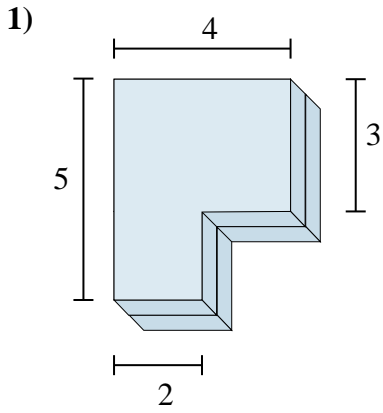

**Respuestas**

1. \_\_\_\_\_
2. \_\_\_\_\_
3. \_\_\_\_\_
4. \_\_\_\_\_
5. \_\_\_\_\_
6. \_\_\_\_\_



Encontrar el valor total de cada figura mostrada.

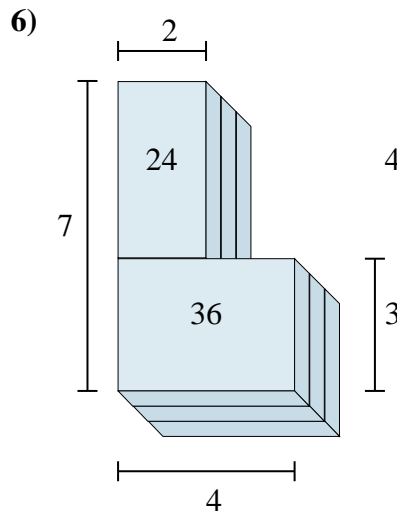
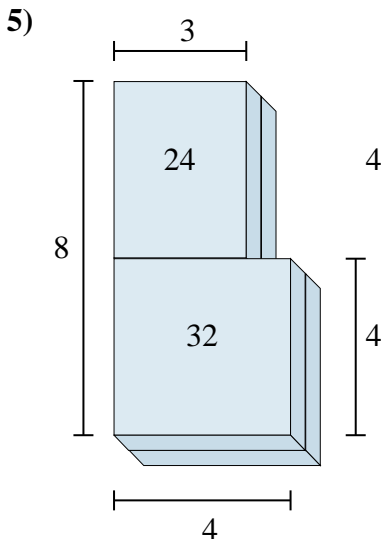
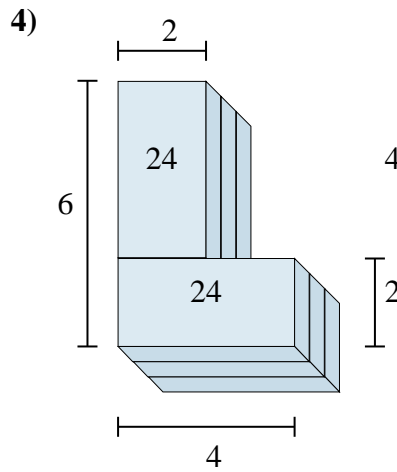
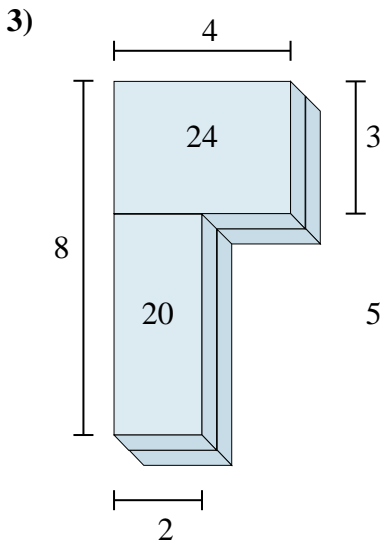
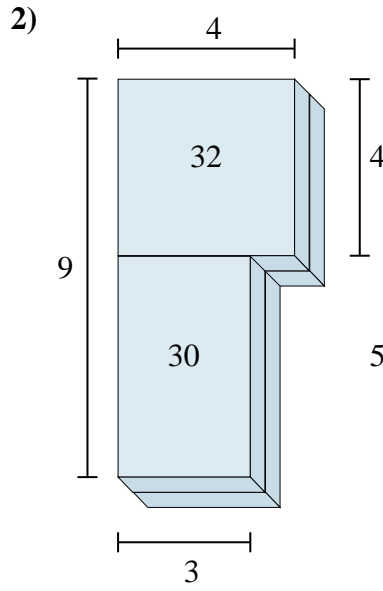
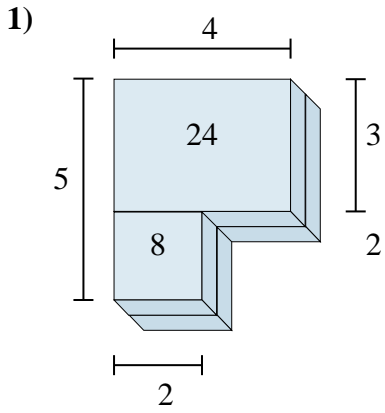

Respuestas

1. 32cm<sup>3</sup>

2. 62cm<sup>3</sup>

3. 44cm<sup>3</sup>

4. 48cm<sup>3</sup>

5. 56cm<sup>3</sup>

6. 60cm<sup>3</sup>



Encontrar el valor total de cada figura mostrada.

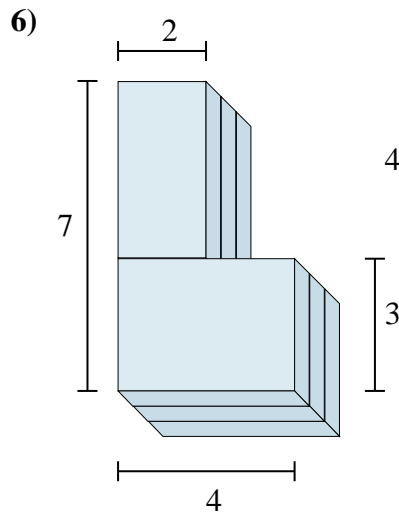
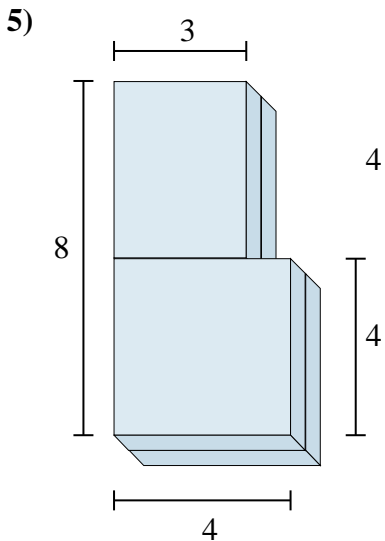
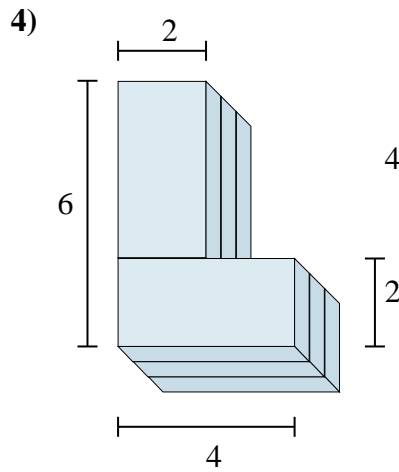
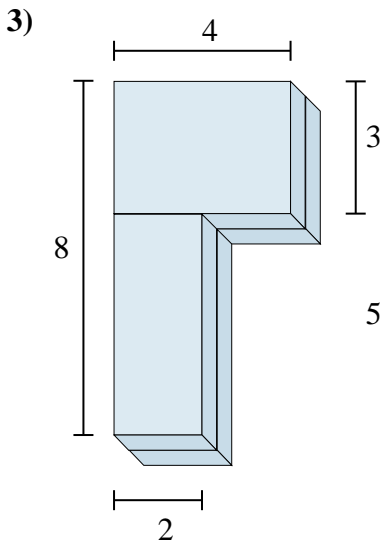
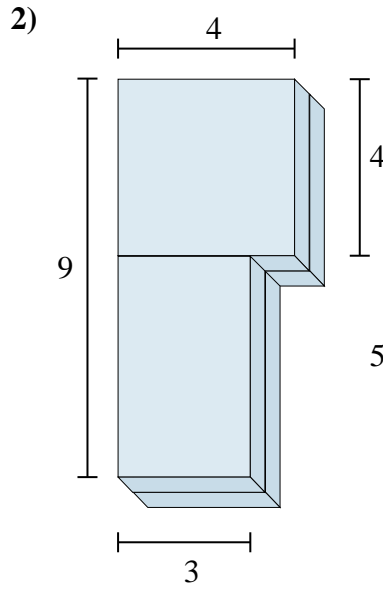
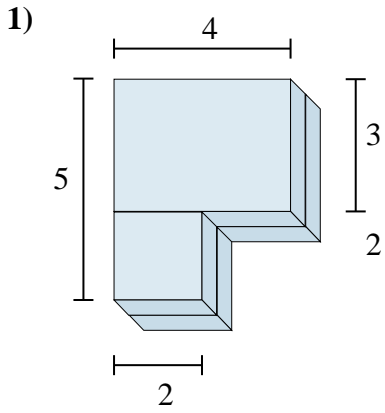

**Respuestas**

1. \_\_\_\_\_

2. \_\_\_\_\_

3. \_\_\_\_\_

4. \_\_\_\_\_

5. \_\_\_\_\_

6. \_\_\_\_\_