

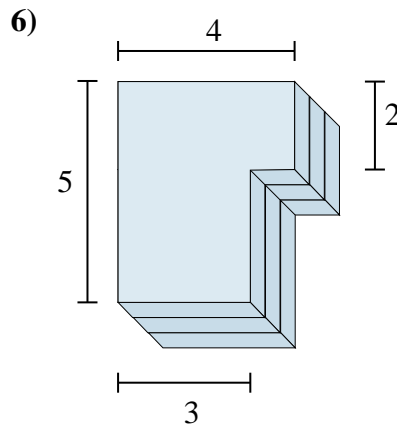

Encontrar el valor total de cada figura mostrada.

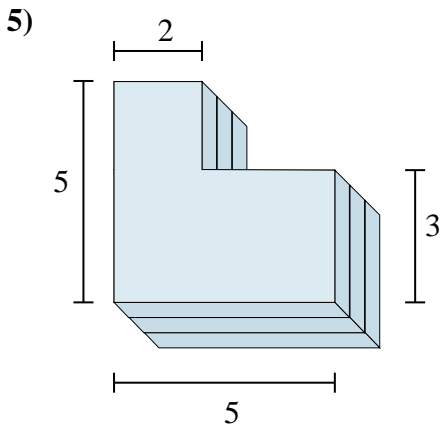
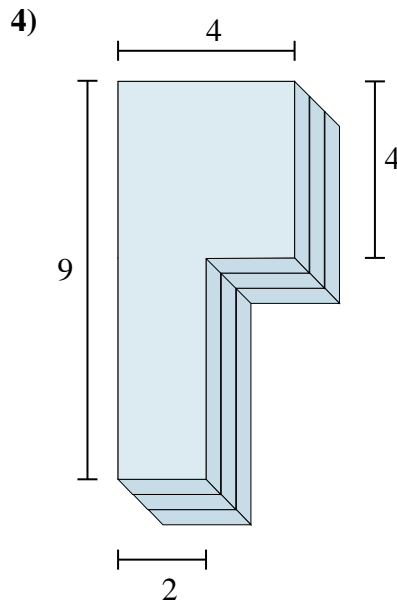
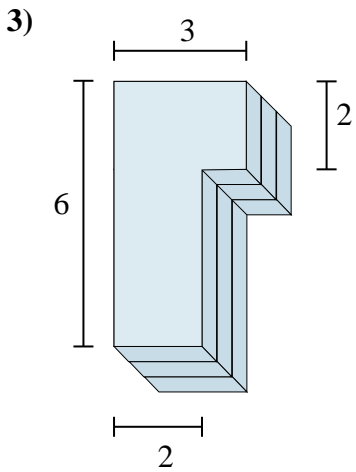
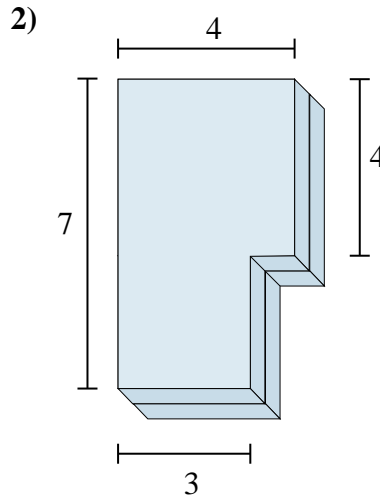
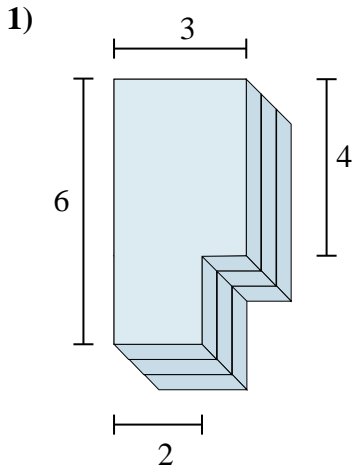

Respuestas

1. _____
2. _____
3. _____
4. _____
5. _____
6. _____



Encontrar el valor total de cada figura mostrada.

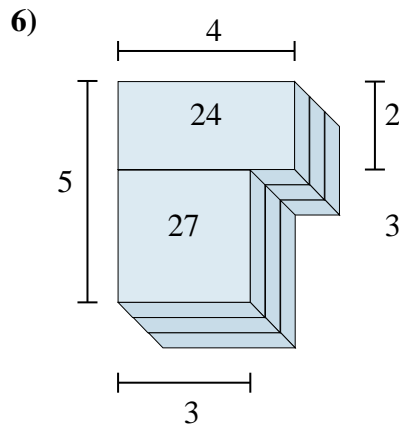
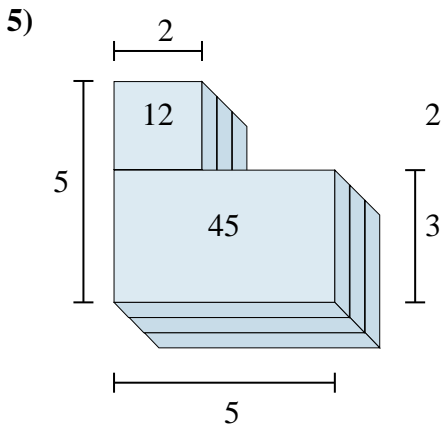
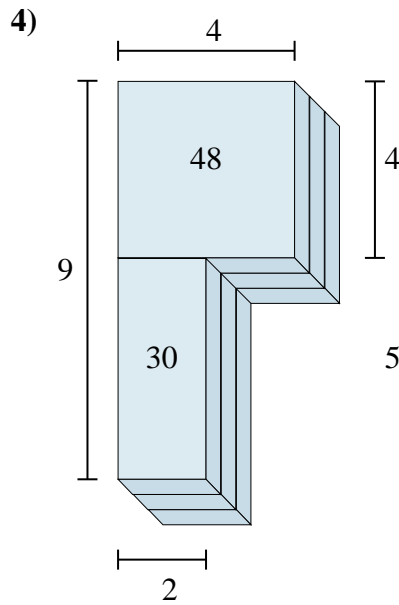
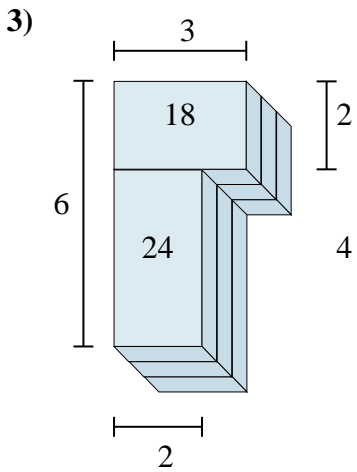
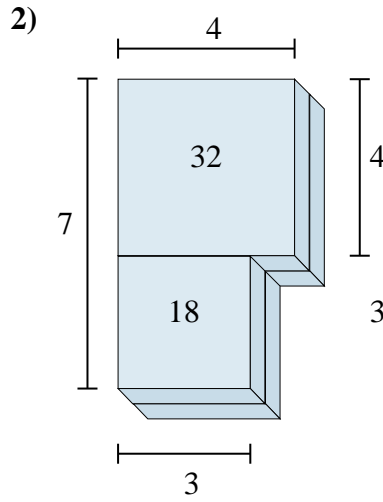
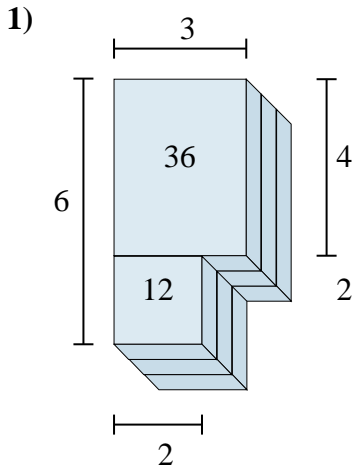

Respuestas

1. 48cm³

2. 50cm³

3. 42cm³

4. 78cm³

5. 57cm³

6. 51cm³



Encontrar el valor total de cada figura mostrada.

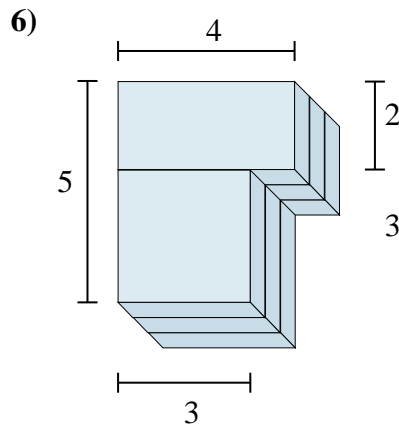
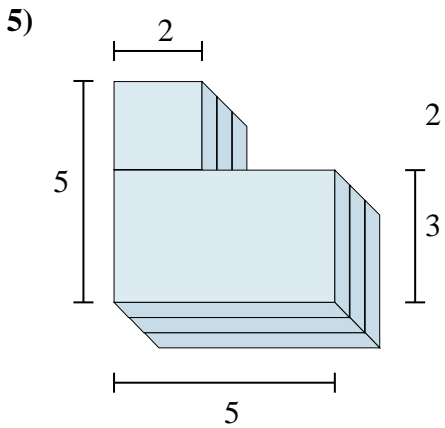
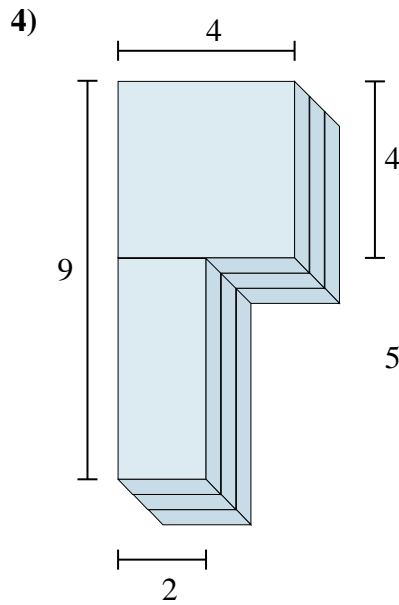
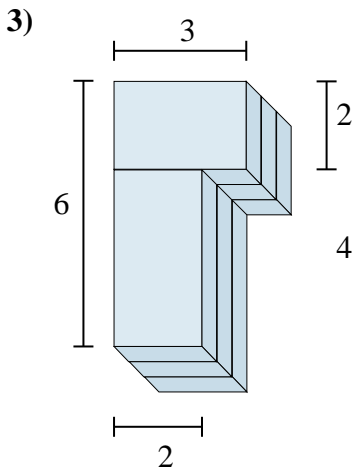
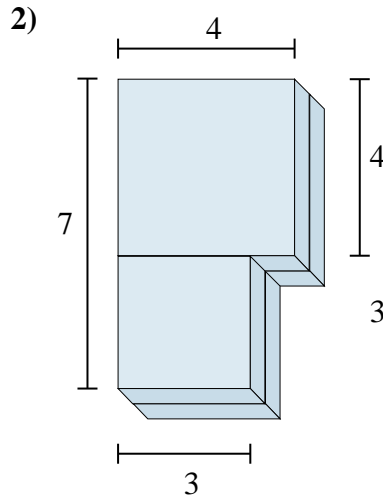
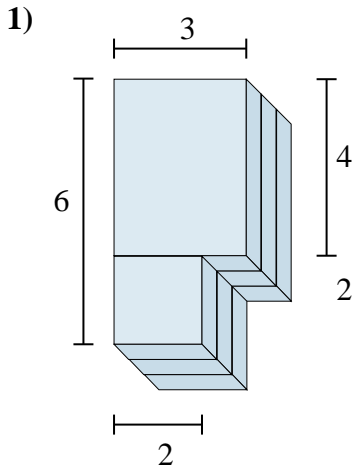

Respuestas

1. _____

2. _____

3. _____

4. _____

5. _____

6. _____