

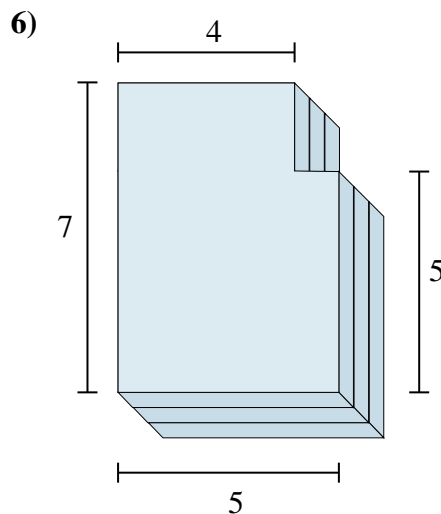

Encontrar el valor total de cada figura mostrada.

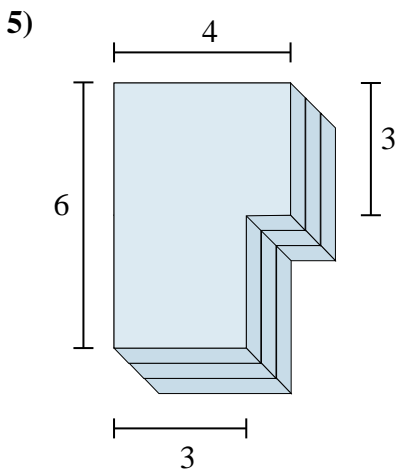
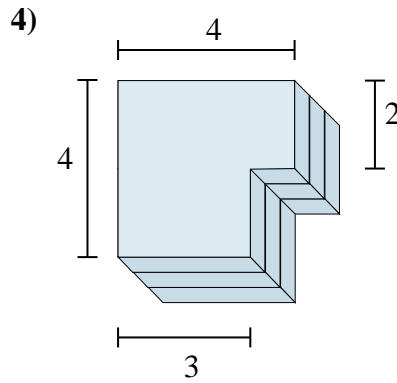
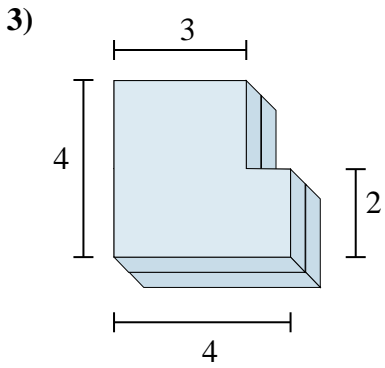
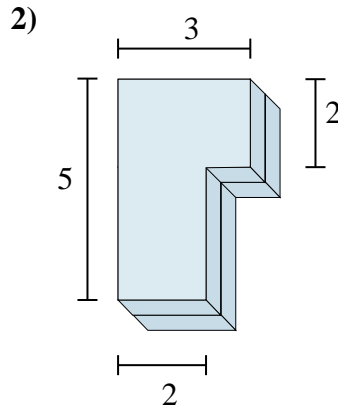
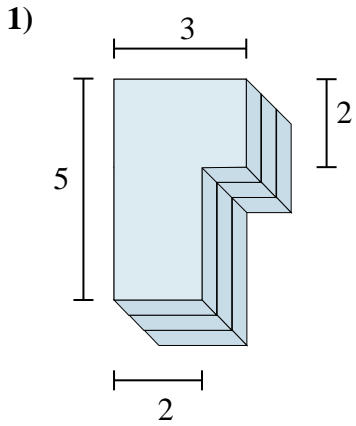

Respuestas

- 1. _____
- 2. _____
- 3. _____
- 4. _____
- 5. _____
- 6. _____



Encontrar el valor total de cada figura mostrada.

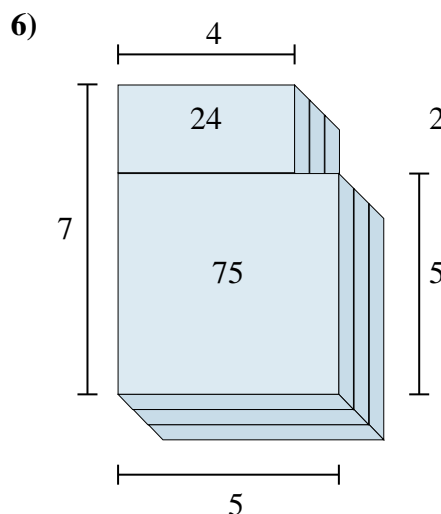
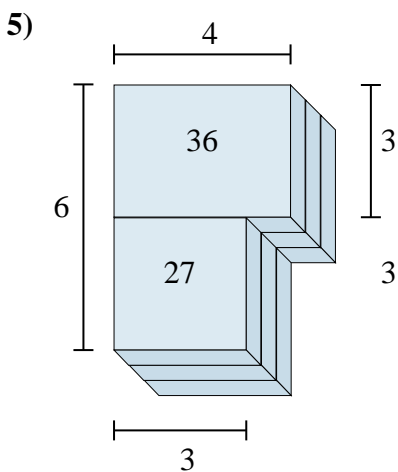
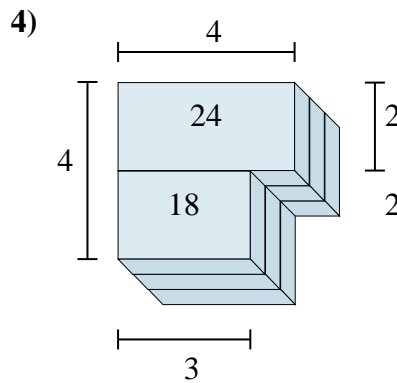
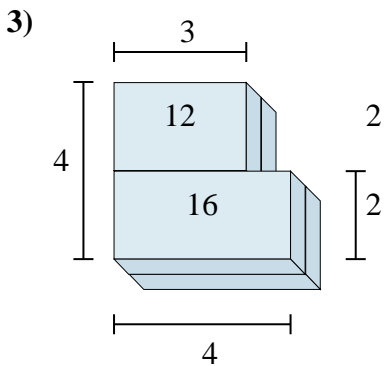
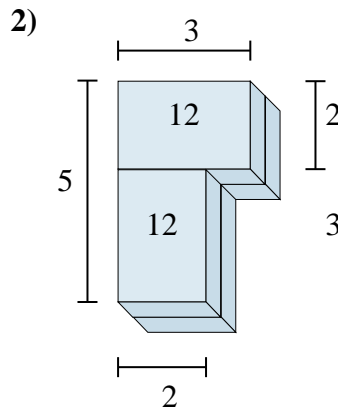
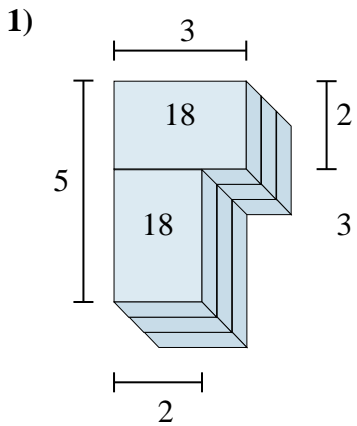

Respuestas

1. 36 cm³

2. 24 cm³

3. 28 cm³

4. 42 cm³

5. 63 cm³

6. 99 cm³



Encontrar el valor total de cada figura mostrada.

1)

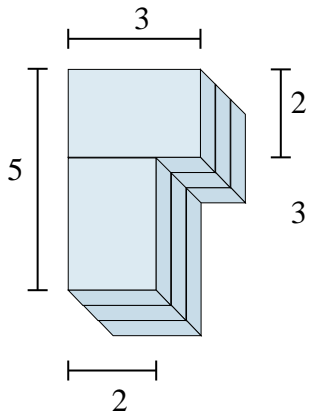

2)

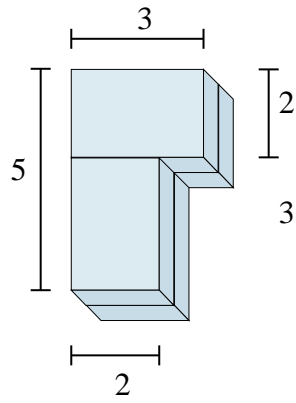

3)

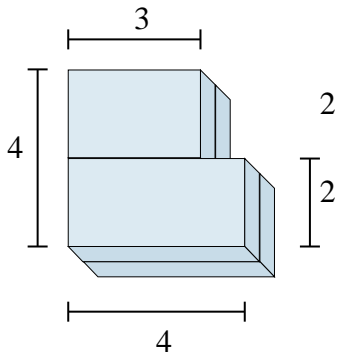

4)

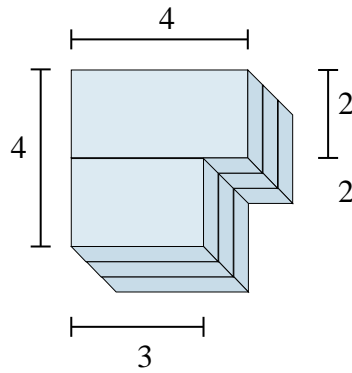

5)

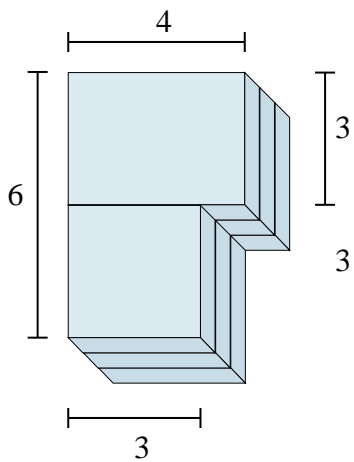

6)

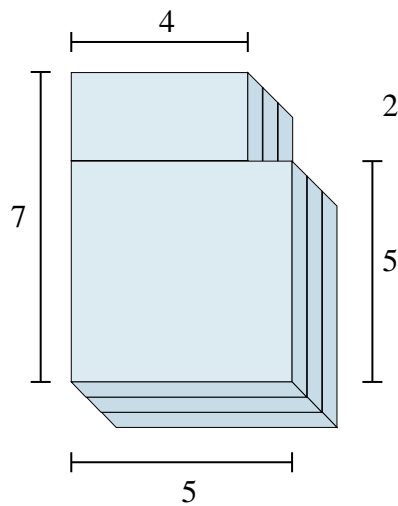

Respuestas

1. _____
2. _____
3. _____
4. _____
5. _____
6. _____