

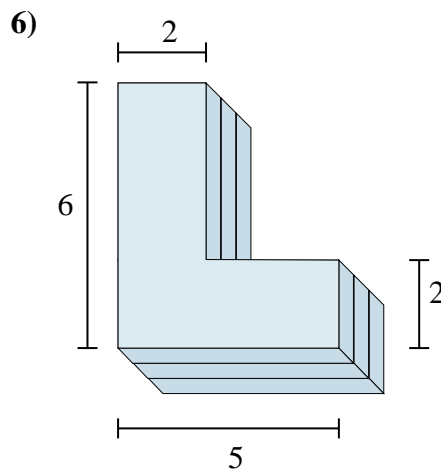

Encontrar el valor total de cada figura mostrada.

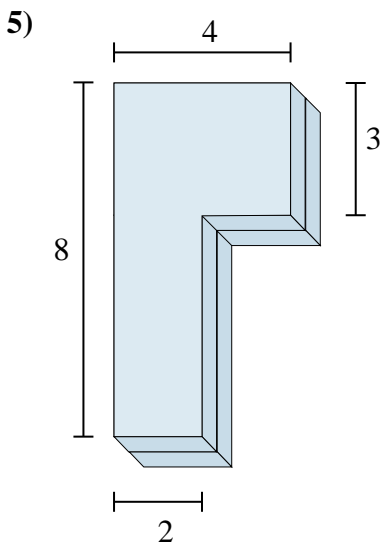
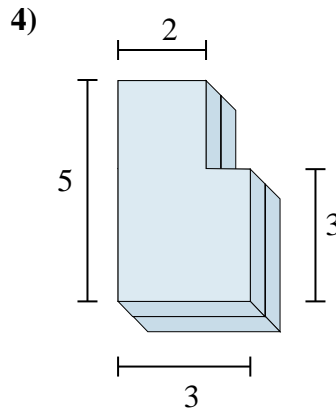
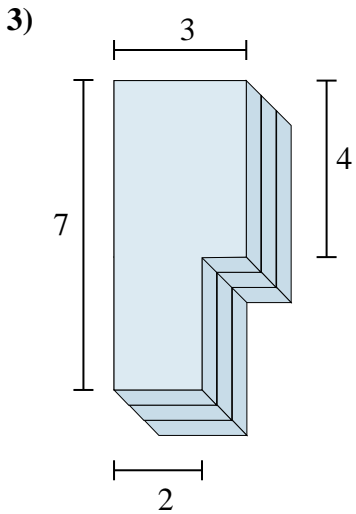
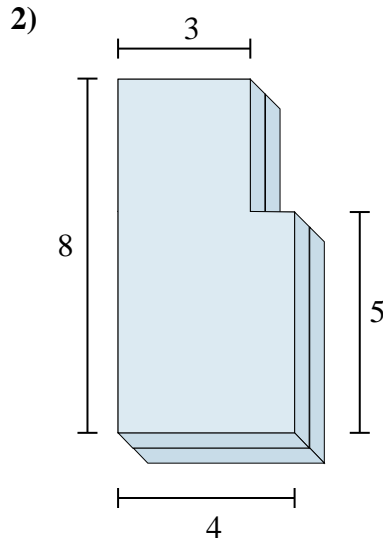
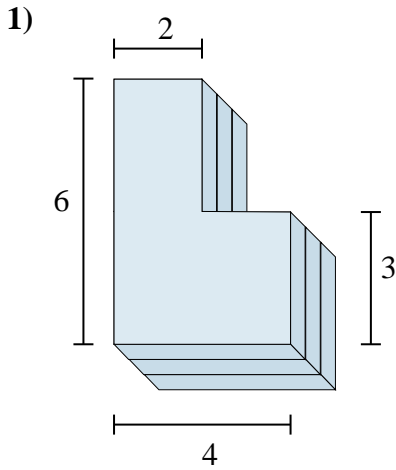

Respuestas

- 1. _____
- 2. _____
- 3. _____
- 4. _____
- 5. _____
- 6. _____



Encontrar el valor total de cada figura mostrada.

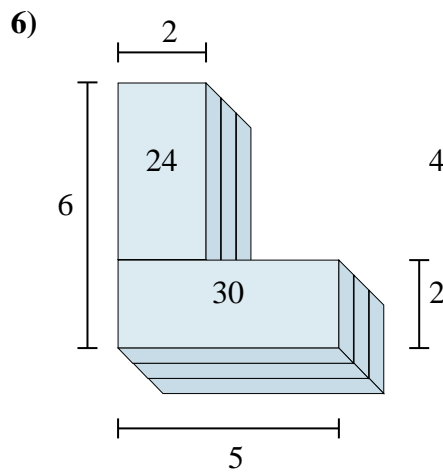
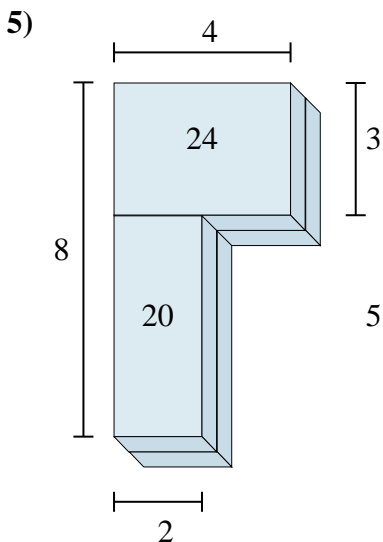
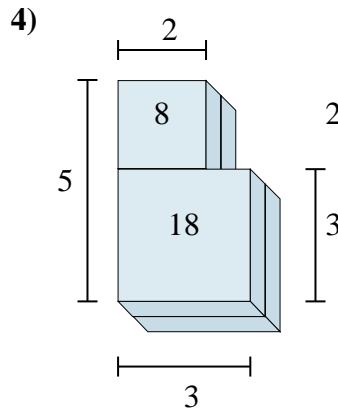
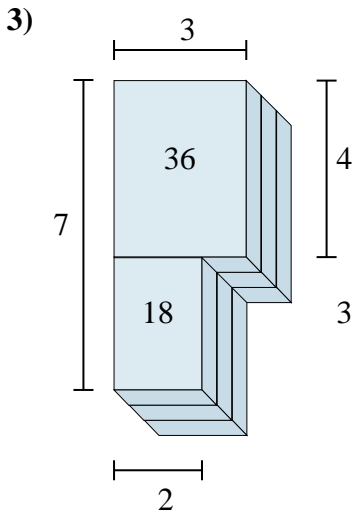
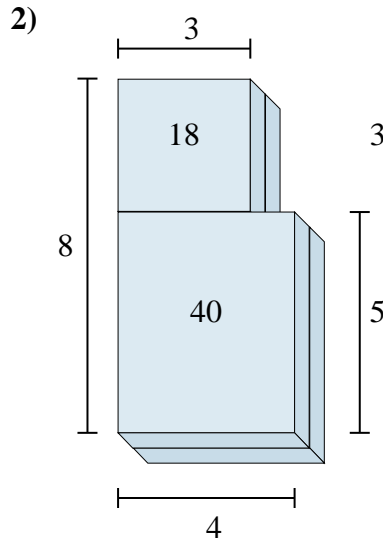
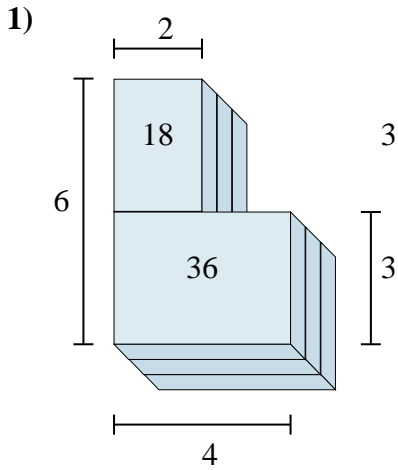

Respuestas

1. 54 cm³

2. 58 cm³

3. 54 cm³

4. 26 cm³

5. 44 cm³

6. 54 cm³



Encontrar el valor total de cada figura mostrada.

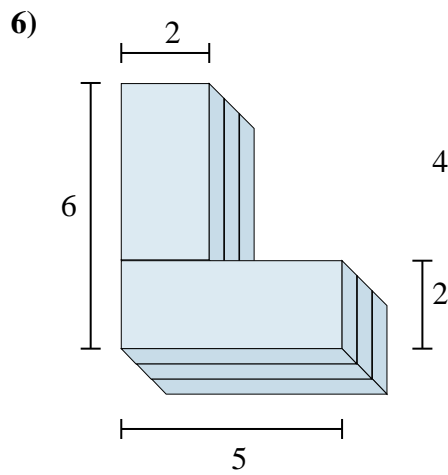
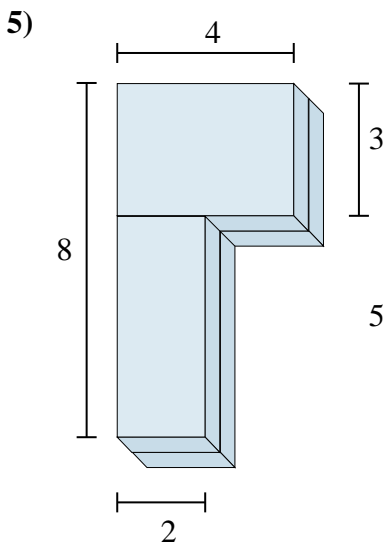
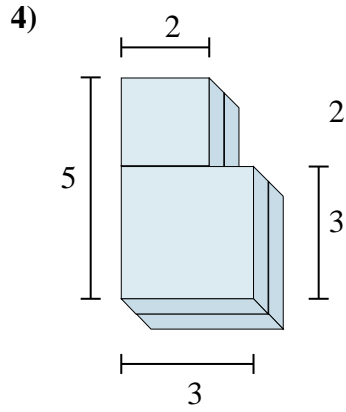
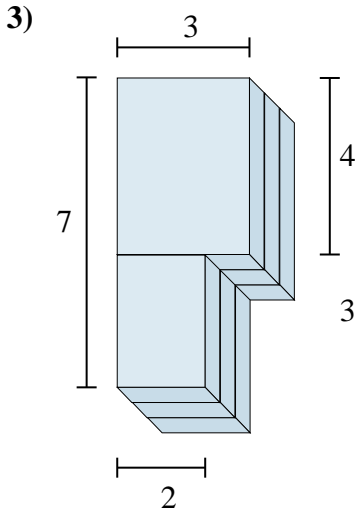
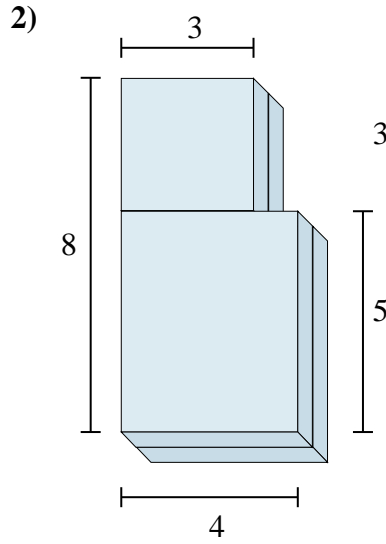
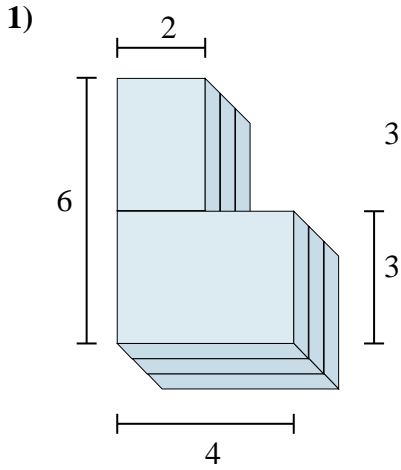

Respuestas

1. _____
2. _____
3. _____
4. _____
5. _____
6. _____